

PRODUCT NUMBER  
SEE PART NO. SCHEME

- NOTE:  
1. MATERIAL:  
HOUSING: NYLON 66, HALOGEN FREE  
UL94V-0, COLOR: BLACK  
2. REFER GS-20-0399 APPLICATION SPECIFICATION  
FOR MATING CONNECTOR.  
3. PRODUCT SPECIFICATION: GS-12-1177.  
4. PACKAGE SPECIFICATION: GS-14-2359 (BULK PACKED)  
5. APPLICATION SPECIFICATION: GS-20-0399.  
6. LEAD FREE PRODUCTS MEET EUROPEAN UNION  
DIRECTIVES AND OTHER COUNTRY REGULATIONS AS  
DESCRIBED IN GS-47-0004  
7. PART NUMBER SCHEME:  
10136653- XX X LF

NO OF POS  
02: 2 POS.  
5  
12: 12 POS.  
LEAD FREE  
GLOW WIRE COMPATIBLE  
BLANK: NON COMPATIBLE  
G: COMPATIBLE

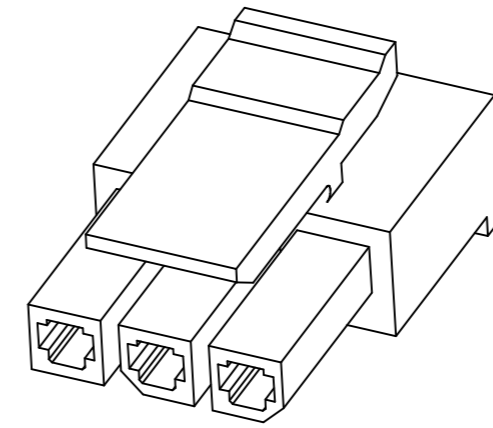
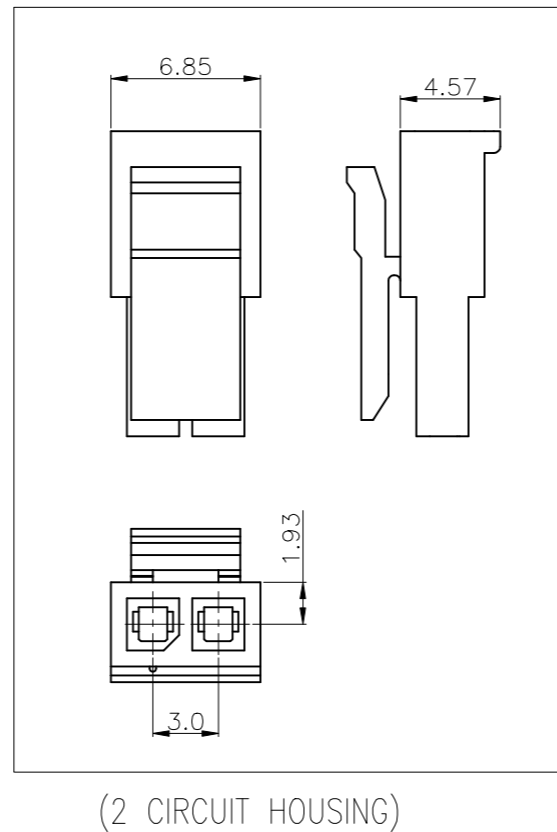
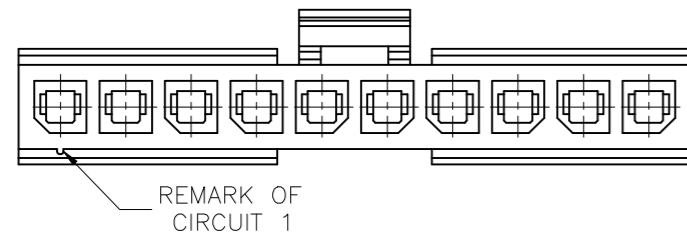
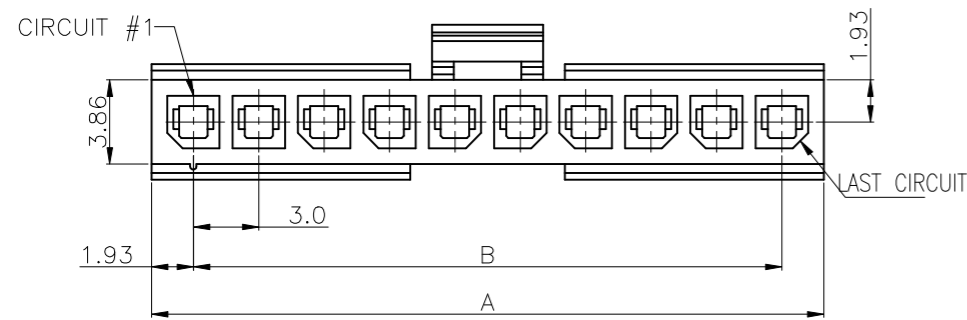
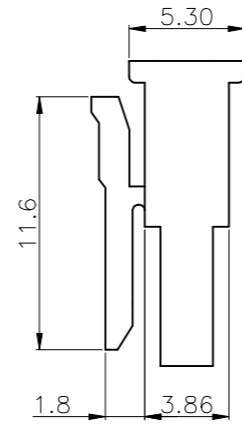
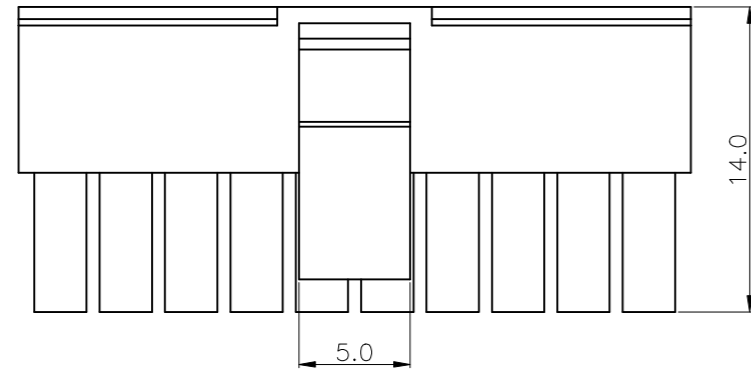

PART NO.	POS.	A	B
10136653-02XLF	02	/	3.00
10136653-03XLF	03	9.85	6.00
10136653-04XLF	04	12.85	9.00
10136653-05XLF	05	15.85	12.00
10136653-06XLF	06	18.85	15.00
10136653-07XLF	07	21.85	18.00
10136653-08XLF	08	24.85	21.00
10136653-09XLF	09	27.85	24.00
10136653-10XLF	10	30.85	27.00
10136653-11XLF	11	33.85	30.00
10136653-12XLF	12	36.85	33.00

mat'l. code			surface ISO 1302 <input checked="" type="checkbox"/> ISO 406 ISO 1101			tolerance tolerances unless otherwise specified			projection mm			product family MINITEK PWR3.0		
ltr			ecn no			dr			date			title		
A			--			TAI			2015-09-23			MINITEK PWR3.0 WIRE CONNECTOR, RECEPTACLE HSG, SINGLE ROW		
B			ELX-T-24691			TAI			2016-08-10			angles linear		
C			ELX-N-27430			TONY			2017-07-10			scale N.T.S		
D			ELX-I-43460			ASLAM			2022-01-17			sheet no		
									dr			sheet 1 of 2		
									engr			size		
									KENNY TAI			A3		
									2015-08-21			10136653		
									AKHIL RAJAN			type		
									2022-01-17			Product Customer Drawing		
									chr					
									MITHUN PAUL					
									2022-01-17					
									appd					
									SPK					
sheet index			revision sheet			D D								
1			1			2								

Amphenol FCI  
 2016 AFCl  
 © 2016 AFCl  
 D



© 2016 AFCI

D

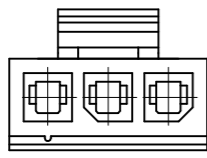

3 POS

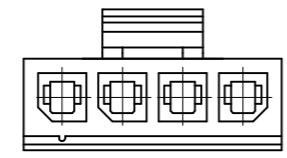

4 POS

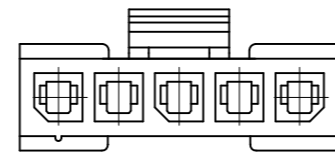

5 POS

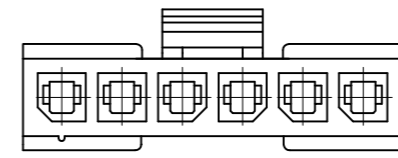

6 POS

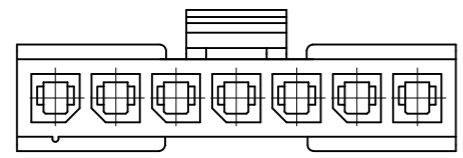

7 POS

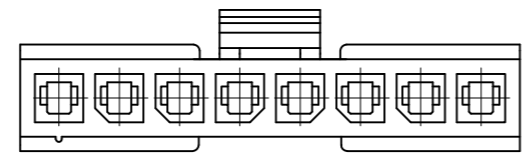

8 POS

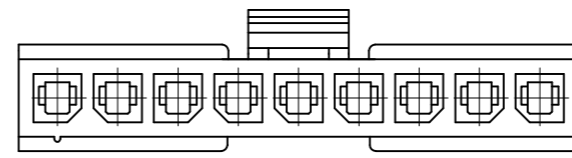

9 POS

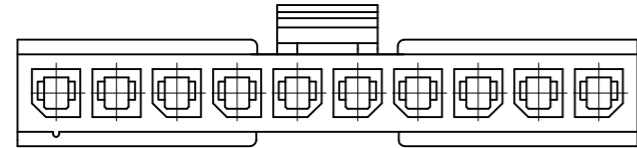

10 POS

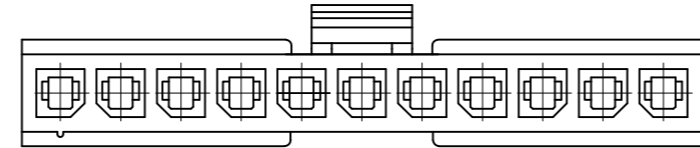

11 POS

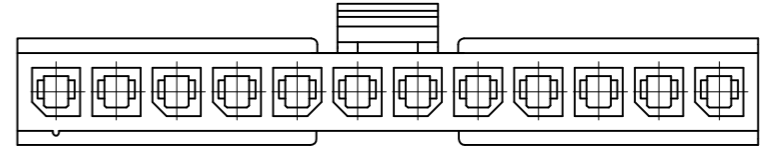

12 POS

mat'l. code				surface <input checked="" type="checkbox"/> ISO 1302 <input type="checkbox"/> ISO 406 <input type="checkbox"/> ISO 1101		tolerance		projection		product family					
ltr				ecn no		dr		date		tolerances unless otherwise specified		title		MINITEK PWR3.0	
										.X±.30		mm		MINITEK PWR3.0 WIRE CONNECTOR, RECEPTACLE HSG, SINGLE ROW	
										.XX±.20		scale N.T.S			
										0°±3'				dwg no sheet 2 of 2 size	
										dr KENNY TAI 2015-08-21		Amphenol FCI		10136653 A3	
										engr AKHIL RAJAN 2022-01-17					
										chr MITHUN PAUL 2022-01-17					
										appd SPK 2022-01-17				type Product Customer Drawing	
sheet index		revision sheet		D 1		D 2									